



Atacadão

AUTOMOTIVO

★ 20 Anos ★

CATÁLOGO DE PRODUTOS

PLATÔS E DISCOS DE EMBREAGEM 100% NOVOS





Parceiros





Fundada em 2004, nossa empresa Atacadão Automotivo é referência nacional, especializada no seguimento de embreagens ZF SACHS, EATON, VALEO e LUK para veículos leves, médios, pesados e agrícolas.

Atuamos com importação e distribuição de embreagens novas, rolamentos, revestimentos e componentes de embreagem.

Temos um amplo estoque de embreagens novas e completas como platôs, discos, rolamentos e atuadores para toda linha de ônibus e caminhões de 280mm a 430mm Mercedes-Benz, Volkswagen, Scania, Volvo, Iveco, Ford e MAN.

Todos os nossos produtos são produzidos em fábricas que atuam com padrão de qualidade original de montadoras, com Certificação Internacional ISO9001, ISO14001 e ISO27001 atestando máxima qualidade e performance.

Nossa linha de embreagens PREMIUM AUTOMOTIVE se destaca pela durabilidade extrema e máxima eficiência, sendo indicada tanto para micro ônibus rodoviário de baixo esforço, quanto para carretas Rodotrem de trabalho extra severo, fidelizando nossos clientes com o mais importante pré-requisito; a confiança no produto.



Índice

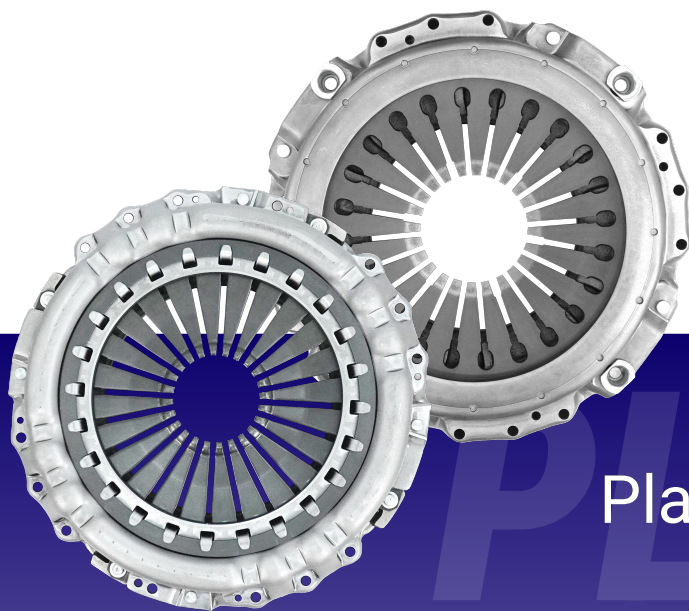

Platô de Embreagem

Pág 5

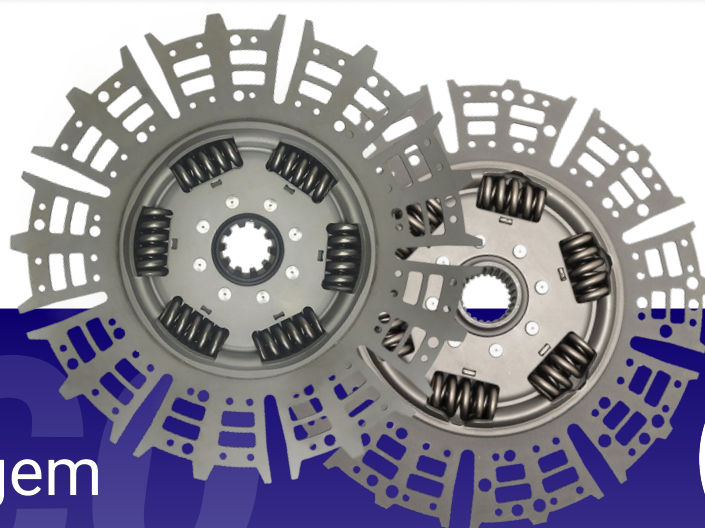

Disco de Embreagem

Pág 8



Atuador de Embreagem

Pág 13



PLATÔ DE EMBREAGEM

VOLVO D13 I-SHIFT 430MM
cód:0002

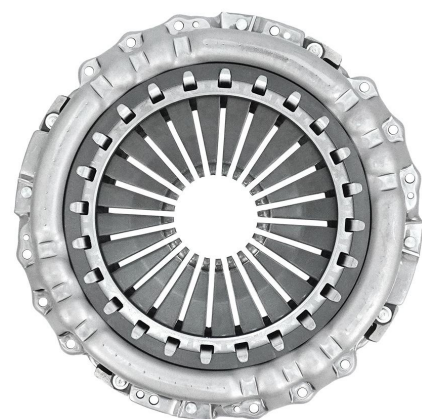

MICRO / FORD 13" 11.130 / 8.140 /
9.150 330MM
cód:0003

MB1417 362MM
cód:0004

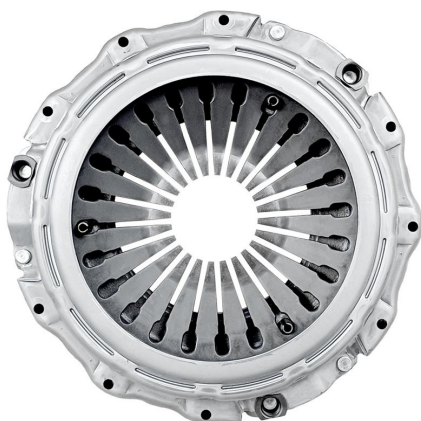
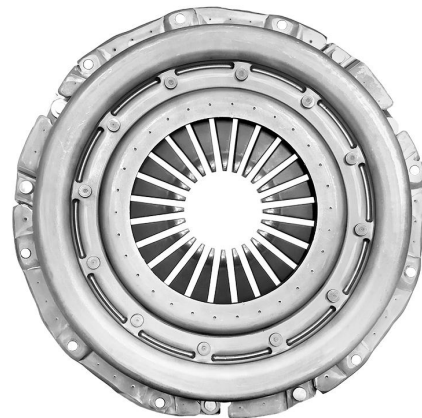

VW TITAN 18.310 380MM
cód:0005



PLATÔ DE EMBREAGEM

MB1722 395MM
cód:0006



SCANIA 124 / 113 430MM
cód:0007

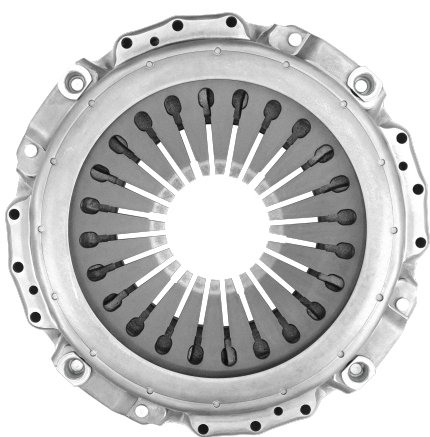

VOLVO FH / NH 430MM
cód:0008



VOLKSBUS EATON 365MM
cód:0009

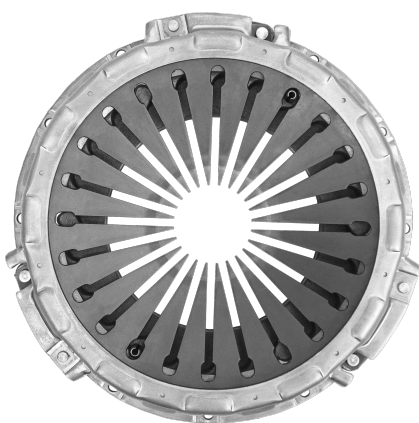



PLATÔ DE EMBREAGEM

FORD CARGO 2429 EATON 395MM
cód: **0010**

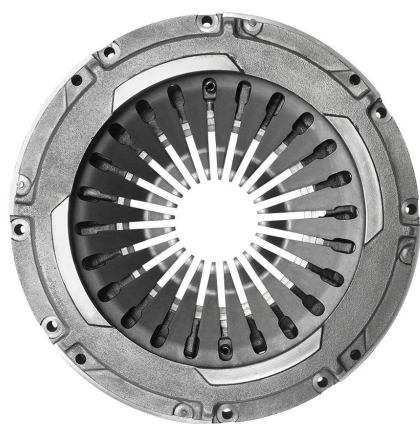

VOLVO VM EATON 395MM
cód: **0011**

MB 1938 430MM
cód: **0012**

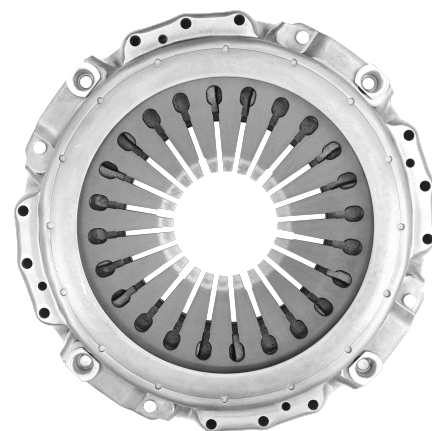

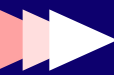

DISCO DE EMBREAGEM

4000

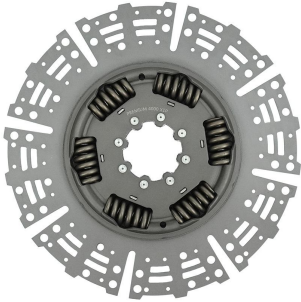

INTERNO NEW ACTROS
400MM (SACHS 5051)

4000-E

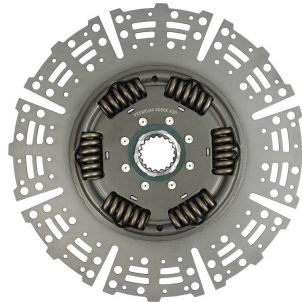

EXTERNO NEW ACTROS
400MM (SACHS 5582)

4001

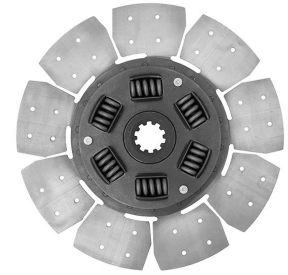

GM C-10

4002

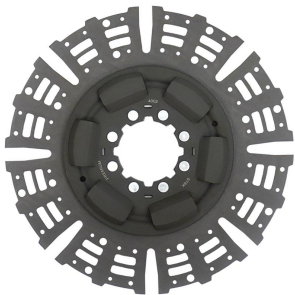

DUPLO INTERNO MB 2638
10 ESTRIAS 400MM (SACHS 5577)

4002-E

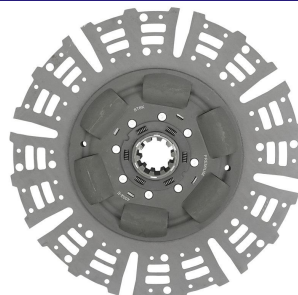

DUPLO EXTERNO MB 2638
10 ESTRIAS 400MM (SACHS 5576)

4003

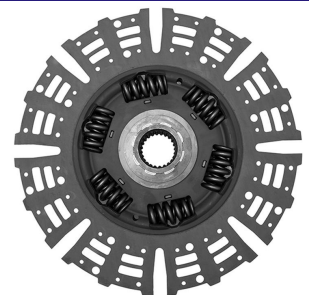

DUPLO INTERNO VOLVO FH
24 ESTRIAS 400MM (SACHS 5577)

4003-E

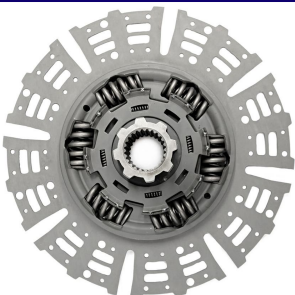

DUPLO EXTERNO VOLVO FH
24 ESTRIAS 400MM (SACHS 5583)

4004

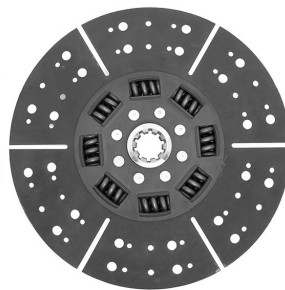

MB 1313 310MM (SACHS 5391)

4005

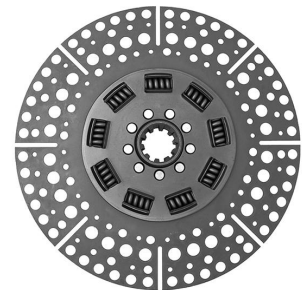

MB 1620 SACHS 9 MOLAS 350MM

4006

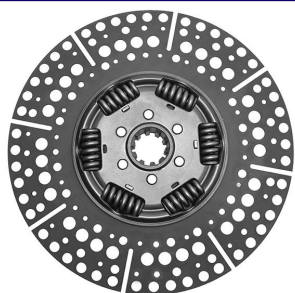

MB 1620 MODERNO SACHS
6 MOLAS 350MM

4007



MB 1417/1418 18 ESTRIAS ELETRÔNICO COM
PRÉ-DAMPER 362MM (SACHS 5523)

4008

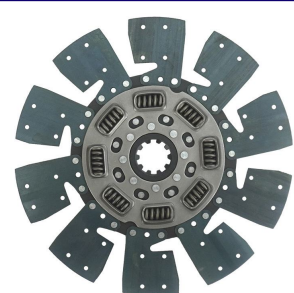

VOLKSBUS EATON 365MM

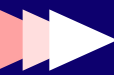

DISCO DE EMBREAGEM

4009

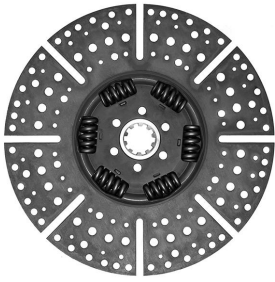

VW TITAN COM PRÉ DAMPER
380MM (SACHS 5453)

4010

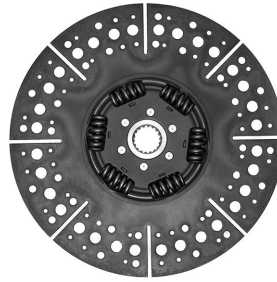

MB 1722 18 ESTRIAS C/ PRÉ-DAMPER
4 MOLAS 395MM (SACHS 5766)

4011

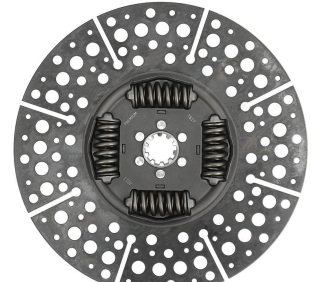

FORD 13" C/ PRÉ-DAMPER
10 ESTRIAS 325MM (SACHS 5086)

4012

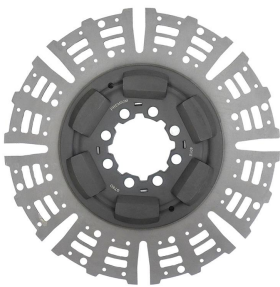

DUPLO INTERNO MB AXOR
18 ESTRIAS 400MM

4012-E

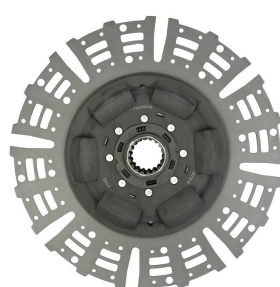

DUPLO EXTERNO MB AXOR
18 ESTRIAS 400MM

4013

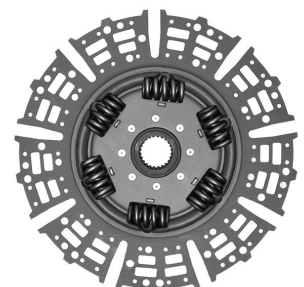

MB / SCANIA SÉRIE 5 / VOLVO 24 ESTRIAS
PRÉ-AMORTECIMENTO 430MM (SACHS 5453)

4014

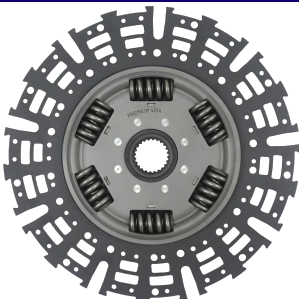

VOLVO D-13 / I-SHIFT 24 ESTRIAS
430MM (SACHS 5012)

4015

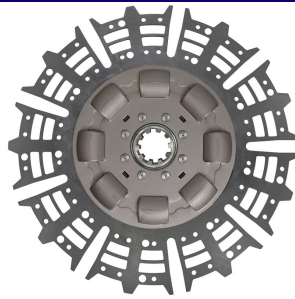

SCANIA / MERCEDES O-400 10
ESTRIAS 8 MOLAS 430MM (SACHS 5705)

4016



SCANIA 124 24 ESTRIAS C/ PRÉ-DAMPER 8
MOLAS 430MM (SACHS 5722)

4017

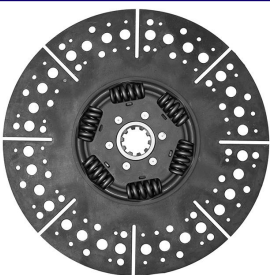

VW CONSTELLATION 10 ESTRIAS
C/ PRÉ DAMPER 395MM (SACHS 5597)

4018



VOLKSBUS EATON MODERNO
5 MOLAS 365MM

4019

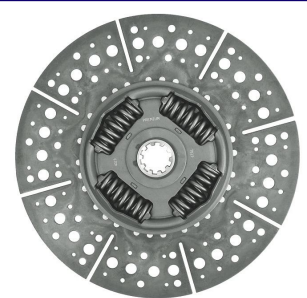

MOTOR MAN 10 ESTRIAS 4 MOLAS 395MM

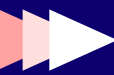

DISCO DE EMBREAGEM

4020



SCANIA SÉRIE 4 VALEO 24 ESTRIAS 430MM

4021



SCANIA SÉRIE 5 VALEO
24 ESTRIAS 430MM

4022

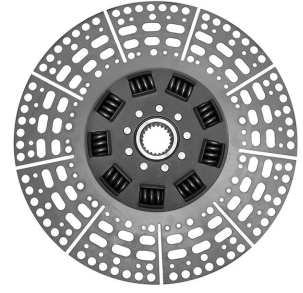

SCANIA 112 22 ESTRIAS 420MM
(SACHS 5345)

4023

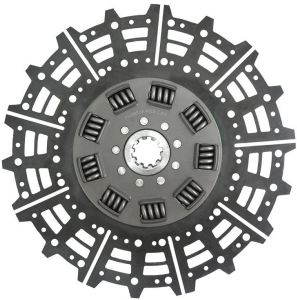

SCANIA 110/111 ESTRIA GROSSA
10 ESTRIAS 420MM (SACHS 5331)

4024



IVECO DAILY VALEO 280MM

4025

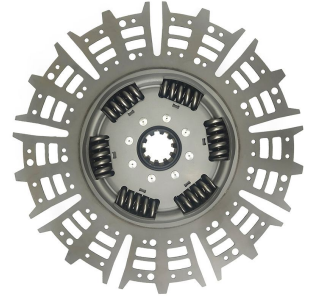

VW / MB / IVECO 10 ESTRIAS
6 MOLAS ABERTAS 430MM

4026



VOLVO I-SHIFT (ROBOCOP) 24 ESTRIAS

4027



GM D10 / D20 SACHS 250MM

4028



MB 1113 SACHS 280MM (SACHS 5346)

4029

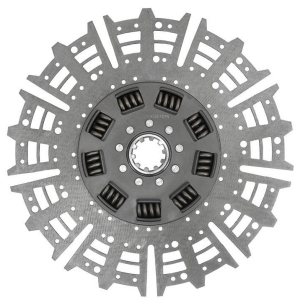

VOLVO NL12 9 MOLAS
10 ESTRIAS 430MM

4030

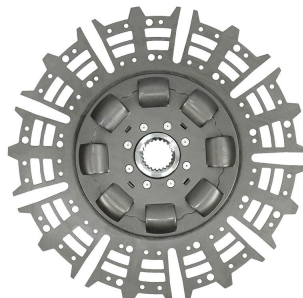

SCANIA 113 8 MOLAS
22 ESTRIAS 430MM

4031

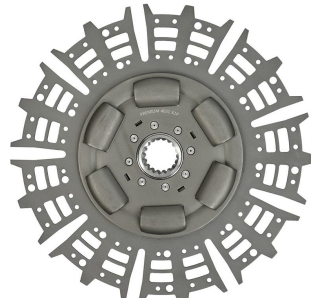

MB1938 AXOR 18 ESTRIAS 430MM
(SACHS 5535)

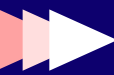

DISCO DE EMBREAGEM

4032



IVECO VERTIS 4 MOLAS 362MM

4033



MB 710 PLUS SACHS 310MM

4034



FORD F-1.000 SACHS 280MM

4035

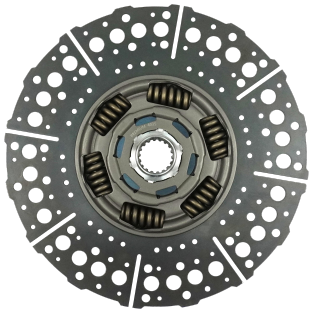

MB 1418 6 MOLAS SACHS 362MM

4036

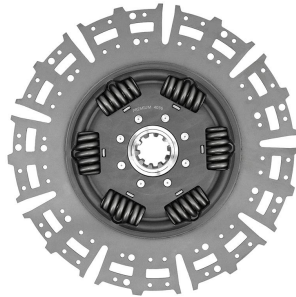

VW METEOR 28.460 / 29.530 MAN
10 ESTRIAS 430MM

4037

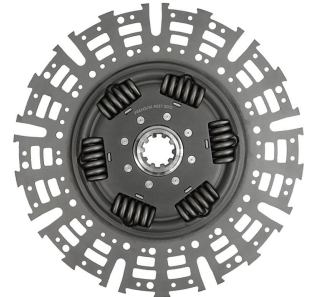

VW TGX MAN 10 ESTRIAS 430MM

4038

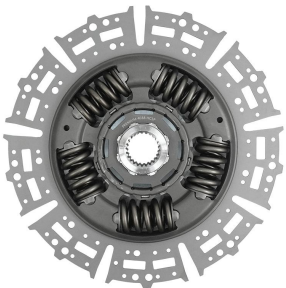

VOLVO I-SHIFT ROBOCOP
MOD NOVO 24 ESTRIAS 430MM

4039

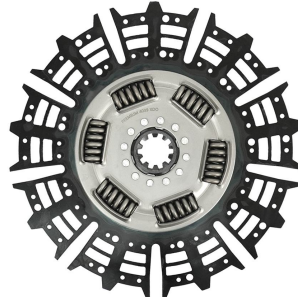

VW / MB EATON 10 ESTRIAS 430MM

4040



FORD CARGO EATON 395MM

4041



VOLVO VM EATON 395MM

4042



GM 13" / FORD 13" SACHS 327MM

4043



GM D60 / FORD 12" SACHS 300MM

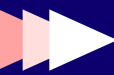

DISCO DE EMBREAGEM

4044



FORD CARGO SACHS 350MM

4045



MB 366 SACHS 330MM

4046

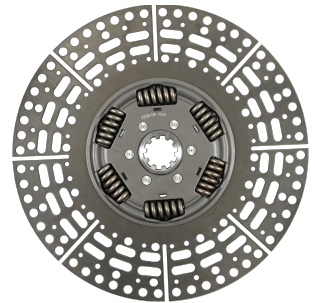

VW TITAN SEM PRE-DAMPER
6 MOLAS 380MM

4055

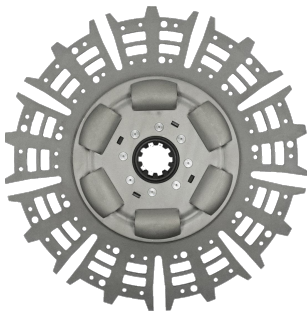

MB 0500 / VW 31.320 6 MOLAS 430MM

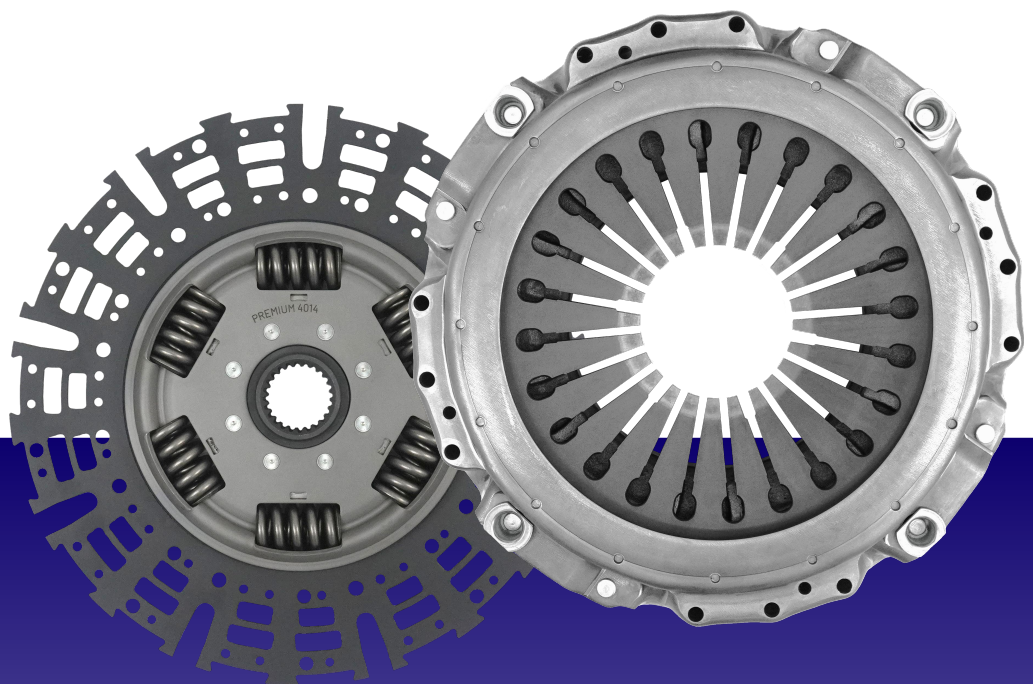

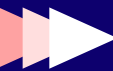

ATUADOR DE EMBREAGEM

6013



MB1418 ELETRÔNICO 362MM

6025



VOLVO D13 / I-SHIFT 430MM





19 Anos de Tradição



Atacadão

AUTOMOTIVO

★ 20 Anos ★

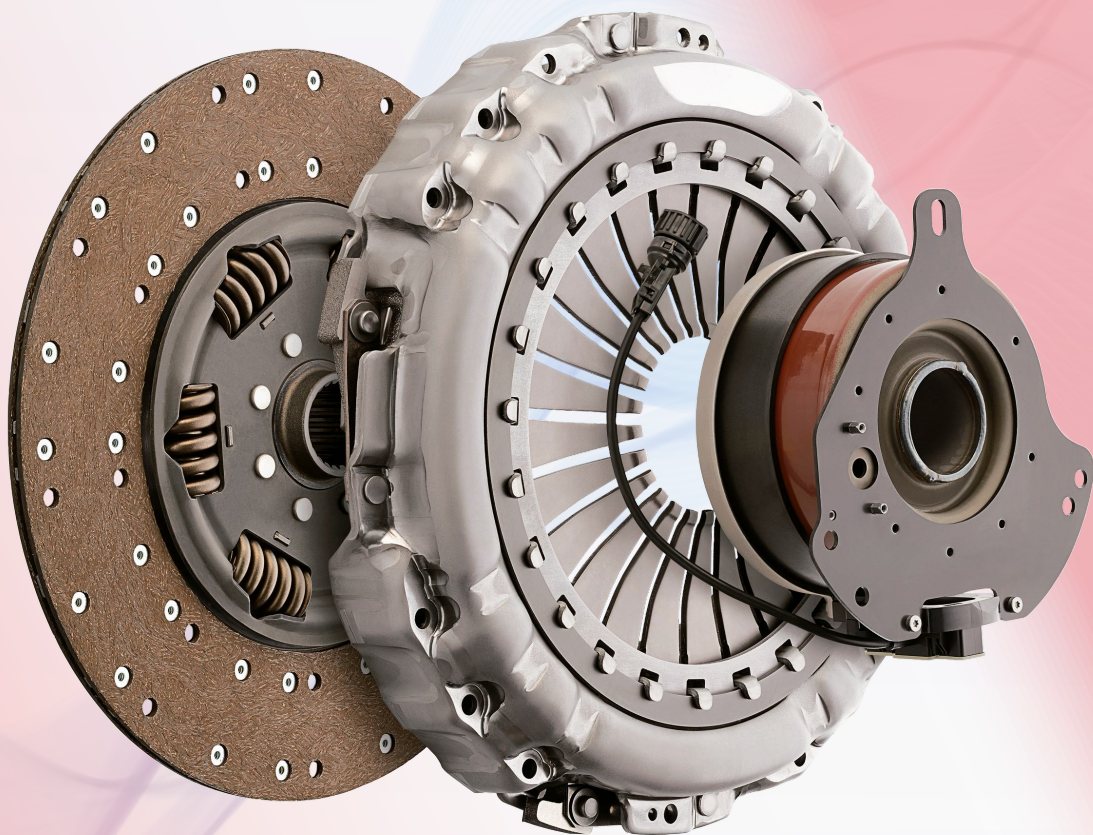

WhatsApp

Tel (11) 2414-2409 / 2421-0714

Cel (11) 98178-3735 / 94060-1888 

Rua Jose Damiani, 103 • Guarulhos • CEP: 07030-240

www.atacadoautomotivo.com

 /atacadoautomotivo.sp

 /atacado.automotivo

 /atacadoautomotivo

